

| Revisions | | | |
|-----------|------------------------|----------|------------|
| Rev | Description | Approved | Date |
| 1 | Issue for design | SC | 10/20/2024 |
| 2 | Update to requirements | SC | 10/20/2024 |
| 3 | Update to requirements | SC | 10/20/2024 |

AGNEL INTERFACE BOARD

| | | | |
|-----------------------|------------|----------------------|------------|
| Company: Insight SIP | | | |
| Customer: Insight SIP | | | |
| Approvals | | Date | |
| Design: SC | 10/20/2024 | 10/20/2024 | 10/20/2024 |
| Issue: SC | 10/20/2024 | 10/20/2024 | 10/20/2024 |
| Scale: NA | A0 | Drawing no: SC130604 | Rev: B |
| | | | Sheet 1/2 |

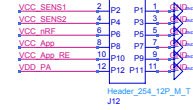
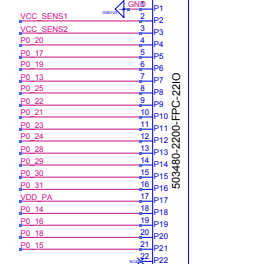
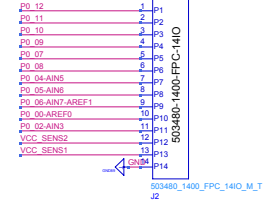
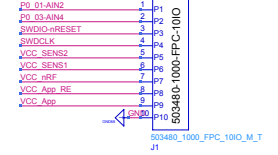
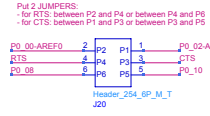
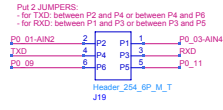
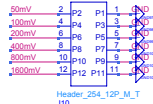
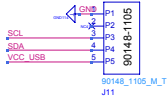
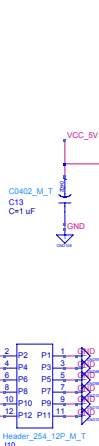
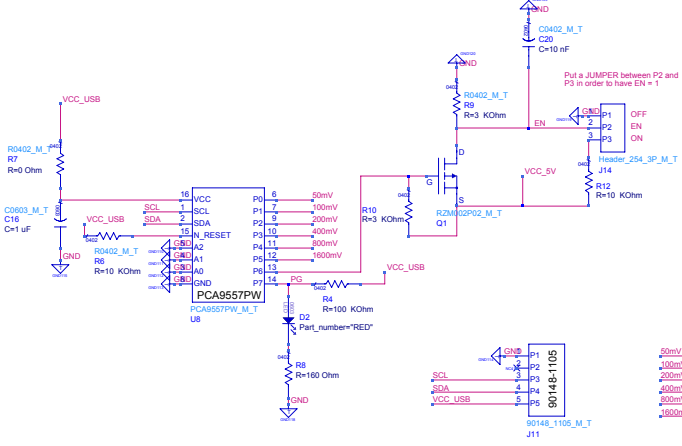
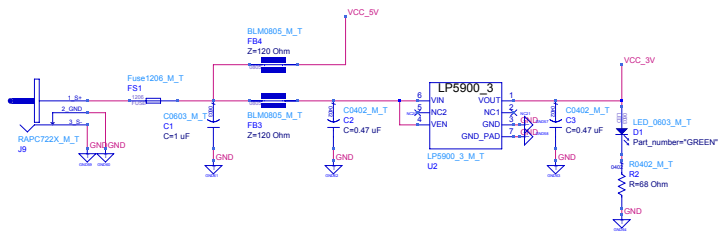

I Total

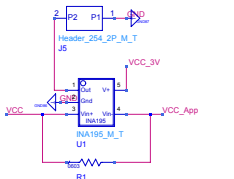

I nRF51 only

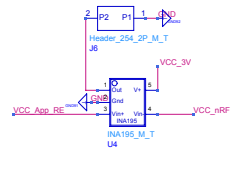

I SENSOR1 only

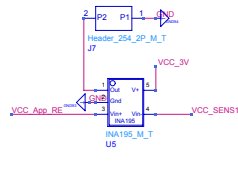

I SENSOR2 only

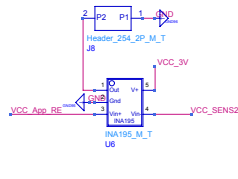

equivalent to PORT0 on nRFGo

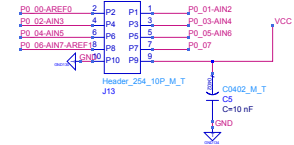

equivalent to PORT1 on nRFGo

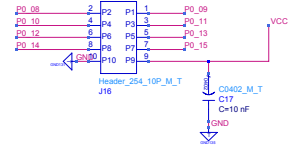

equivalent to PORT2 on nRFGo

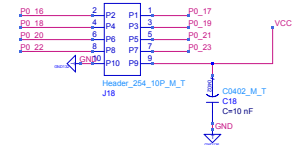

equivalent to PORT3 on nRFGo

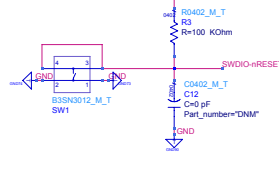
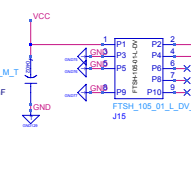
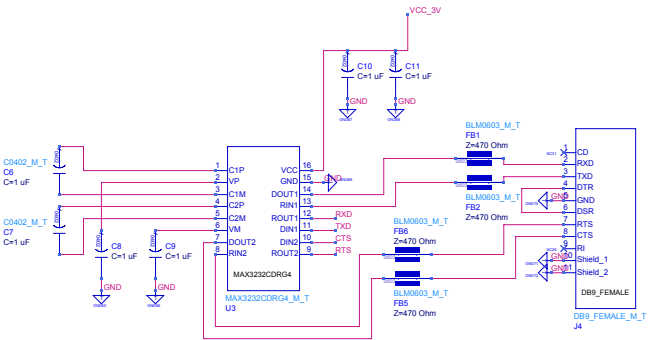
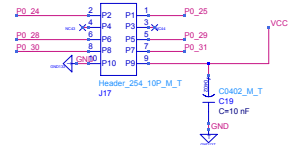

样品 & 报价联系：
南频科技有限公司
陈小姐(销售工程师)
座机：0755-82565851
手机：156-2521-4151
邮件：dwin100@dwintech.com

Insight SiP 代理商联系方式:

电话:0755-82565851

邮件:dwin100@dwintech.com

手机:156-2521-4151

网址: <http://www.dwintech.com/insight%20Pamphlet.html>

深圳市南频科技有限公司